



High quality thermal blinds, windows and mosquito-nets  
for RV lifestyle



# CATALOG

20

26

20

27



# OUR STORY



All our products are designed and manufactured in our factory in Sasso Marconi, Bologna: we are particularly keen on carrying on the tradition of “**handmade**” which represents an important working method in the history of Italian craftsmanship and “**made in Italy**”.

In addition to tradition, however, we are aware of the need to embrace new technologies and more sustainable working styles: in fact, NRF adheres to the “*green purchase behaviour*”, that is encouraging sustainable production and contributing to the protection of natural resources through a “*greener*” economy: we include the use of recycled (or recyclable) materials, reducing CO2 emissions during production and consequently also pollution in favor of the ecosystem.

scan to view or download  
all our products information!



1997

NRF was founded in 1997 under the leadership of Livio Piccini and Gianni Mazzei in Pioppe di Salvaro, a small town in the province of Bologna.

2000

From a small family-run business, within just a few years of its founding, NRF began to establish itself on the national and international markets.

2017

In 2017, the company moved to Sasso Marconi, also in the province of Bologna, purchasing a 1.800 SQM warehouse and doubling its workforce.

2026

Since 2018 onwards, NRF has invested in next-generation machinery and has increasingly dedicated itself to research and development of new products. It has become increasingly recognized and established itself on the global market, exporting its products to various parts of the world.

# CATALOG INDEX

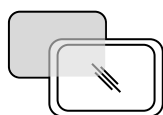

## INTERNAL BLINDS

*THERMO-SHIELD* internal blinds (**pages 4 to 7**)  
*THERMOMAG* internal blinds (**pages 8 & 9**)  
*DARKSHADE* internal blinds (**pages 10 & 11**)  
*THERMO-SHIELD* for Seitz-Dometic® internal blinds (**page 12**)  
*DO-IT-YOURSELF KIT* for internal blinds (**page 13**)

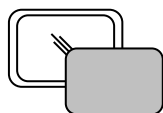

## EXTERNAL BLINDS

*COVER-THERM* external blinds (**page 14**)  
*COVERTECH EVOLUTION* external blinds (**page 15**)  
*COVER-THERM* for Seitz-Dometic® external blinds (**page 16**)



## ROLLS OF FABRIC

3-layer *COUPLED ROLL MATERIAL* (**page 17**)  
7-layer *QUILTED ROLL MATERIAL* (**page 17**)  
8-layer *QUILTED ROLL MATERIAL* (**page 17**)  
9-layer *QUILTED ROLL MATERIAL* (**page 17**)

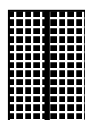

## MOSQUITO-NETS

*MAG-NETS* mosquito-nets for sliding doors (**page 18**)  
*MAG-NETS* mosquito-nets for rear doors (**page 18**)  
*MAG-NETS* mosquito-nets for driver's cab windows (**page 18**)

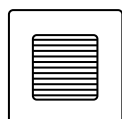

## VENTILATION GRILLES

*AIRVAN* ventilation grilles (**page 19**)

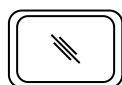

## WINDOW PANELS

*EUROPA* panels (**page 20**)  
*DOUBLE GLAZED* panels (**page 21**)  
*AFRICA* panels (**page 22**)  
*ASIA* panels (**page 23**)  
*OCEANIA* panels (**page 24**)  
*FRANCIA & ARCA* panels (**page 25**)

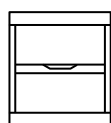

## MOSQUITO-NET BLINDS

*MOD.2* mosquito-net blinds (**page 26**)  
*MOD. 3 014* mosquito-net blinds (**page 27**)  
*MOD. EVO* mosquito-net blinds (**page 28**)  
*MOD. FS* mosquito-nets or blinds (**page 29**)



## ACCESSORIES & SPARE PARTS

For internal & external blinds (**page 30**)  
For mosquito-net blinds (**page 31**)  
For window panels (**pages 32 & 33**)

# THERMO-SHIELD

Our evergreen product that never disappoints

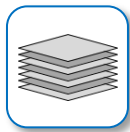

**7-layer material**



**Radiation Reflective**



**Insulating hot & cold**



**Fixation with suction cups**



**Available in grey or black**

- They include reflective aluminum and insulating materials that prevent both heating and cold.
- No drills, screws, or external tracks required. The suction cups allow you to apply and remove the blinds in seconds.
- Custom-cut to fit specific vehicle windows, so they provide absolute privacy.
- They block out almost all external light, significantly improving sleep quality.
- The thermal blind acts as a protective shield from direct sunlight and UV rays.
- Practical storage: once folded or rolled up, they take up very little space (they are sold with a dedicated carry bag).
- They are produced internally in our factory: this allows us to have fast delivery times and guarantee consistent quality.

*Very wide availability of sets and models*

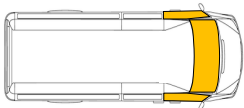

**DRIVER'S CAB SET**

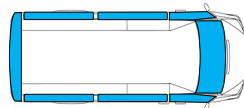

**COMPLETE SET**

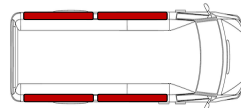

**LIVING AREA**

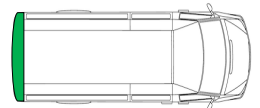

**REAR SET**

**GREY COLOR**



**BLACK COLOR**



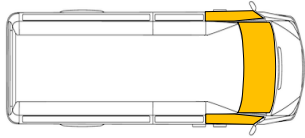

DRIVER'S CAB SET



| VEHICLE                             | YEAR        | Grey ART. CODE | Black ART. CODE |
|-------------------------------------|-------------|----------------|-----------------|
| CITROEN BERLINGO                    | 1996 - 2007 | 889BP          | 889BP-N         |
|                                     | 2008 - 2017 | 892BP          | 892BP-N         |
|                                     | > 2018      | 884BPC         | 884BPC-N        |
| CITROEN CAMPSTER - VANSTER          | > 2017      | 850CV          | 850CV-N         |
| CITROEN JUMPY - SPACETOURER         | > 2016      | 895SJE         | 895SJE-N        |
| FIAT DUCATO                         | < 1990      | 801FD          | 801FD-N         |
|                                     | 1991 - 1993 | 802FD          | 802FD-N         |
|                                     | 1994 - 2001 | 803FD          | 803FD-N         |
|                                     | 2002 - 2005 | 804FD          | 804FD-N         |
|                                     | 2006 - 2024 | 805FD          | 805FD-N         |
| FIAT SCUDO                          | 2006 - 2016 | 872SJE         | 872SJE-N        |
| FORD TRANSIT                        | < 1986      | 810FT          | 810FT-N         |
|                                     | 1987 - 1997 | 811FT          | 811FT-N         |
|                                     | 1998 - 1999 | 812FT          | 812FT-N         |
|                                     | 2000 - 2014 | 813FT          | 813FT-N         |
|                                     | > 2015      | 839FT          | 839FT-N         |
| FORD CUSTOM                         | 2012 - 2022 | 843FTC         | 843FTC-N        |
|                                     | > 2023      | 844FTC         | 844FTC-N        |
| IVECO DAILY                         | 1987 - 1999 | 838IV          | 838IV-N         |
|                                     | 2000 - 2014 | 825IV          | 825IV-N         |
|                                     | > 2015      | 844IV          | 844IV-N         |
| MERCEDES BENZ SPRINTER              | 1997 - 1999 | 815MS          | 815MS-N         |
|                                     | 2000 - 2005 | 816MS          | 816MS-N         |
|                                     | 2006 - 2017 | 817MS          | 817MS-N         |
|                                     | > 2018      | 845MS          | 845MS-N         |
| MERCEDES BENZ VITO - VIANO - TOURER | < 2003      | 818MV          | 818MV-N         |
|                                     | 2004 - 2014 | 819MV          | 819MV-N         |
|                                     | > 2015      | 879MV          | 879MV-N         |
| NISSAN NV 200                       | 2009 - 2021 | 824NV          | 824NV-N         |
| RENAULT TRAFIC                      | 1981 - 2001 | 822RT          | 822RT-N         |
|                                     | 2002 - 2014 | 823RT          | 823RT-N         |
|                                     | > 2015      | 846RT          | 846RT-N         |
| RENAULT MASTER                      | 1998 - 2003 | 820RM          | 820RM-N         |
|                                     | 2004 - 2010 | 821RM          | 821RM-N         |
|                                     | > 2011      | 897RM          | 897RM-N         |
| RENAULT KANGOO                      | 1997 - 2007 | 824RK1         | 824RK1-N        |
|                                     | > 2008      | 840RK1         | 840RK1-N        |
| VOLKSWAGEN LT 28                    | < 1996      | 810VW          | 810VW-N         |
| VOLKSWAGEN T2 - T3                  | 1979 - 1989 | 806VW          | 806VW-N         |
| VOLKSWAGEN T4                       | 1990 - 2002 | 807VW          | 807VW-N         |
| VOLKSWAGEN T5 - T6 - T6.1           | 2003 - 2023 | 808VW          | 808VW-N         |
| VOLKSWAGEN MULTIVAN                 | > 2023      | 809VW          | 809VW-N         |
| VOLKSWAGEN TRANSPORTER              | > 2023      | 844FTC         | 844FTC-N        |
| VOLKSWAGEN ID BUZZ                  | > 2023      | 811VW          | 811VW-N         |
| VOLKSWAGEN CADDY                    | 2004 - 2020 | 844VW1         | 844VW1-N        |
|                                     | > 2021      | 845VW          | 845VW-N         |
| VOLKSWAGEN CRAFTER                  | > 2018      | 847VW          | 847VW-N         |

instructions & useful information



# INTERNAL BLINDS

Thermo-shield

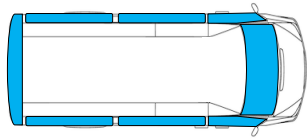

COMPLETE SET



| VEHICLE                             | YEAR           | PARTS               | WHEELBASE       | Grey ART. CODE | Black ART. CODE |          |
|-------------------------------------|----------------|---------------------|-----------------|----------------|-----------------|----------|
| CITROEN BERLINGO                    | 1996 - 2007    | 8                   | 1 sliding door  | 890BP          | 890BP-N         |          |
|                                     |                | 8                   | 2 sliding doors | 890BP1         | 890BP1-N        |          |
|                                     |                | 9                   | 1 sliding door  | 891BP          | 891BP-N         |          |
|                                     |                | 9                   | 2 sliding doors | 891BP1         | 891BP1-N        |          |
|                                     | 2008 - 2017    | 8                   | 1 fixed door    | 893BP          | 893BP-N         |          |
|                                     |                | 8                   | 1 open door     | 893BP1         | 893BP1-N        |          |
|                                     |                | 9                   | short           | 894BP          | 894BP-N         |          |
|                                     |                | 9                   | long            | 894BP1         | 894BP1-N        |          |
|                                     | > 2018         | 8                   | short           | 885BPC         | 885BPC-N        |          |
|                                     |                | 8                   | long            | 885BPC1        | 885BPC1-N       |          |
|                                     |                | 9                   | short           | 886BPC         | 886BPC-N        |          |
|                                     |                | 9                   | long            | 886BPC1        | 886BPC1-N       |          |
| CITROEN CAMPSTER - VANSTER          | > 2017         | 8                   | short           | 850CV8         | 850CV8-N        |          |
| CITROEN JUMPY - SPACETOUREUR        | > 2016         | 8                   | short           | 895SJE8        | 895SJE8-N       |          |
| FIAT SCUDO                          | 2006 - 2016    | 8                   | short           | 873SJE         | 873SJE-N        |          |
|                                     |                | 8                   | long            | 873SJE1        | 873SJE1-N       |          |
|                                     |                | 9                   | short           | 874SJE         | 874SJE-N        |          |
|                                     |                | 9                   | long            | 874SJE1        | 874SJE1-N       |          |
| FORD CUSTOM                         | 2012 - 2022    | 8                   | short           | 858FTC         | 858FTC-N        |          |
|                                     |                | 8                   | long            | 860FTC         | 860FTC-N        |          |
|                                     |                | 9                   | short           | 859FTC         | 859FTC-N        |          |
|                                     |                | 9                   | long            | 861FTC         | 861FTC-N        |          |
|                                     | > 2023         | 8                   | short           | 844FTC8        | 844FTC8-N       |          |
|                                     |                | 8                   | long            | 844FTC10       | 844FTC10-N      |          |
|                                     |                | 9                   | short           | 844FTC9        | 844FTC9-N       |          |
|                                     |                | 9                   | long            | 844FTC11       | 844FTC11-N      |          |
|                                     |                | 8                   | short           | 862MV          | 862MV-N         |          |
|                                     |                | 9                   | short           | 863MV          | 863MV-N         |          |
| MERCEDES BENZ VITO - VIANO - TOURER | 2004 - 2014    | 8                   | short           | 866MV          | 866MV-N         |          |
|                                     |                | 8                   | long            | 868MV          | 868MV-N         |          |
|                                     |                | 8                   | extra-long      | 870MV          | 870MV-N         |          |
|                                     |                | 9                   | short           | 867MV          | 867MV-N         |          |
|                                     |                | 9                   | long            | 869MV          | 869MV-N         |          |
|                                     |                | 9                   | extra-long      | 871MV          | 871MV-N         |          |
|                                     |                | > 2015              | 8               | short          | 880MV           | 880MV-N  |
|                                     |                |                     | 8               | long           | 880MV1          | 880MV1-N |
|                                     | 8              |                     | extra-long      | 880MV2         | 880MV2-N        |          |
|                                     | 9              |                     | short           | 880MV3         | 880MV3-N        |          |
|                                     | NISSAN NV 200  | 2009 - 2021         | 12              | short          | 824NV9          | 824NV9-N |
|                                     | RENAULT TRAFIC | 2002 - 2014         | 8               | short          | 850RT           | 850RT-N  |
| 8                                   |                |                     | long            | 852RT          | 852RT-N         |          |
| 9                                   |                |                     | short           | 851RT          | 851RT-N         |          |
| 9                                   |                |                     | long            | 853RT          | 853RT-N         |          |
| > 2015                              |                | 8                   | short           | 854RT          | 854RT-N         |          |
|                                     |                | 8                   | long            | 856RT          | 856RT-N         |          |
|                                     |                | 9                   | short           | 855RT          | 855RT-N         |          |
|                                     |                | 9                   | long            | 857RT          | 857RT-N         |          |
|                                     |                | 8                   | short           | 824RK          | 824RK-N         |          |
|                                     |                | 9                   | short           | 824RK2         | 824RK2-N        |          |
| > 2008                              | 8              | short               | 840RK           | 840RK-N        |                 |          |
|                                     | 9              | short               | 840RK2          | 840RK2-N       |                 |          |
|                                     | 8              | short               | 840RK3          | 840RK3-N       |                 |          |
| VOLKSWAGEN T2 - T3                  | 1979 - 1989    | 8                   | short           | 806VW8         | 806VW8-N        |          |
| VOLKSWAGEN T4                       | 1990 - 2002    | 8                   | short           | 807VW7         | 807VW7-N        |          |
|                                     |                | 8                   | short w/climate | 807VW11        | 807VW11-N       |          |
|                                     |                | 8                   | long            | 807VW9         | 807VW9-N        |          |
|                                     |                | 9                   | short           | 807VW8         | 807VW8-N        |          |
|                                     |                | 9                   | short w/climate | 807VW12        | 807VW12-N       |          |
|                                     |                | 9                   | long            | 807VW10        | 807VW10-N       |          |
| VOLKSWAGEN T5 - T6 - T6.1           | 2003 - 2023    | 8                   | short           | 808VW8         | 808VW8-N        |          |
|                                     |                | 8                   | short comfort   | 808VW12        | 808VW12-N       |          |
|                                     |                | 8                   | long            | 808VW10        | 808VW10-N       |          |
|                                     |                | 8                   | long comfort    | 808VW14        | 808VW14-N       |          |
|                                     |                | 9                   | short           | 808VW9         | 808VW9-N        |          |
|                                     |                | 9                   | short comfort   | 808VW13        | 808VW13-N       |          |
|                                     |                | 9                   | long            | 808VW11        | 808VW11-N       |          |
|                                     |                | 9                   | long comfort    | 808VW15        | 808VW15-N       |          |
|                                     |                | VOLKSWAGEN MULTIVAN | > 2023          | 8              | short           | 809VW8   |
| 8                                   | long           |                     |                 | 809VW10        | 809VW10-N       |          |
| 8                                   | short          |                     |                 | 844FTC8        | 844FTC8-N       |          |
| VOLKSWAGEN TRANSPORTER              | > 2023         | 8                   | long            | 844FTC10       | 844FTC10-N      |          |
|                                     |                | 9                   | short           | 844FTC9        | 844FTC9-N       |          |
|                                     |                | 9                   | long            | 844FTC11       | 844FTC11-N      |          |
|                                     |                | 8                   | short           | 811VW7         | 811VW7-N        |          |
| VOLKSWAGEN ID BUZZ                  | > 2023         | 8                   | long            | 811VW8         | 811VW8-N        |          |
|                                     |                | 8                   | short           | 844VW          | 844VW-N         |          |
| VOLKSWAGEN CADDY                    | 2004 - 2020    | 8                   | long            | 844VW2         | 844VW2-N        |          |
|                                     |                | 8                   | short           | 845VW7         | 845VW7-N        |          |
|                                     | > 2021         | 8                   | short           | 845VW7         | 845VW7-N        |          |
|                                     |                | 8                   | long            | 845VW8         | 845VW8-N        |          |

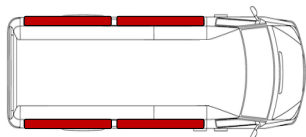

### LIVING AREA SET

| VEHICLE                             | YEAR        | WHEELBASE        | Grey ART. CODE | Black ART. CODE |
|-------------------------------------|-------------|------------------|----------------|-----------------|
| CITROEN BERLINGO                    | 1996 - 2007 | short            | 889BP4         | 889BP4-N        |
|                                     | 2008 - 2017 | short            | 892BP4         | 892BP4-N        |
|                                     | > 2018      | short            | 884BPC4        | 884BPC4-N       |
|                                     |             | long             | 884BPC5        | 884BPC5-N       |
| CITROEN CAMPSTER - VANSTER          | > 2017      | short            | 850CV4         | 850CV4-N        |
| CITROEN JUMPY - SPACETOURER         | > 2016      | short            | 895SJE4        | 895SJE4-N       |
|                                     |             | long             | 895SJE5        | 895SJE5-N       |
|                                     |             | extra-long       | 895SJE6        | 895SJE6-N       |
| FIAT SCUDO                          | 2006 - 2016 | short            | 875SJE         | 875SJE-N        |
|                                     |             | long             | 875SJE1        | 875SJE1-N       |
| FORD CUSTOM                         | 2012 - 2022 | short            | 843FTC4        | 843FTC4-N       |
|                                     |             | long             | 843FTC5        | 843FTC5-N       |
|                                     | > 2023      | short            | 844FTC4        | 844FTC4-N       |
|                                     |             | long             | 844FTC5        | 844FTC5-N       |
| MERCEDES BENZ VITO - VIANO - TOURER | < 2003      | short            | 818MV4         | 818MV4-N        |
|                                     |             | short            | 819MV4         | 819MV4-N        |
|                                     |             | long             | 819MV5         | 819MV5-N        |
|                                     | > 2015      | extra-long       | 819MV6         | 819MV6-N        |
|                                     |             | short            | 879MV4         | 879MV4-N        |
|                                     |             | long             | 879MV5         | 879MV5-N        |
| NISSAN NV 200                       | 2009 - 2021 | short (6 pieces) | 824NV4         | 824NV4-N        |
|                                     |             | short            | 823RT4         | 823RT4-N        |
| RENAULT TRAFIC                      | 2002 - 2014 | long             | 823RT5         | 823RT5-N        |
|                                     |             | short            | 846RT4         | 846RT4-N        |
|                                     | > 2015      | short            | 846RT5         | 846RT5-N        |
|                                     |             | long             | 846RT5         | 846RT5-N        |
| RENAULT KANGOO                      | 1997 - 2007 | short            | 824RK4         | 824RK4-N        |
|                                     | > 2008      | short            | 840RK4         | 840RK4-N        |
| VOLKSWAGEN T2 - T3                  | 1979 - 1989 | short            | 806VW4         | 806VW4-N        |
| VOLKSWAGEN T4                       | 1990 - 2002 | short            | 807VW4         | 807VW4-N        |
|                                     |             | short w/climate  | 807VW6         | 807VW6-N        |
|                                     |             | long             | 807VW5         | 807VW5-N        |
| VOLKSWAGEN T5 - T6 - T6.1           | 2003 - 2023 | short            | 808VW4         | 808VW4-N        |
|                                     |             | short comfort    | 808VW6         | 808VW6-N        |
|                                     |             | long             | 808VW5         | 808VW5-N        |
|                                     |             | long comfort     | 808VW7         | 808VW7-N        |
| VOLKSWAGEN MULTIVAN                 | > 2024      | short            | 809VW4         | 809VW4-N        |
|                                     |             | long             | 809VW5         | 809VW5-N        |
| VOLKSWAGEN TRANSPORTER              | > 2023      | short            | 844FTC4        | 844FTC4-N       |
|                                     |             | long             | 844FTC5        | 844FTC5-N       |
| VOLKSWAGEN ID BUZZ                  | > 2023      | short            | 811VW4         | 811VW4-N        |
|                                     |             | long             | 811VW5         | 811VW5-N        |
| VOLKSWAGEN CADDY                    | 2004 - 2020 | short            | 844VW4         | 844VW4-N        |
|                                     |             | long             | 844VW5         | 844VW5-N        |
|                                     | > 2021      | short            | 845VW4         | 845VW4-N        |
|                                     |             | long             | 845VW5         | 845VW5-N        |

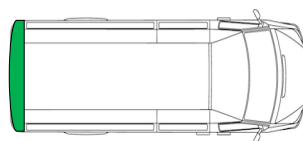

### REAR SET

| VEHICLE                             | YEAR        | PARTS        | Grey ART. CODE | Black ART. CODE |
|-------------------------------------|-------------|--------------|----------------|-----------------|
| CITROEN BERLINGO                    | 1996 - 2007 | 1            | 889BP1         | 889BP1-N        |
|                                     |             | 2            | 889BP42        | 889BP42-N       |
|                                     | 2008 - 2017 | 1            | 892BP1         | 892BP1-N        |
|                                     |             | 2            | 892BP412       | 892BP412-N      |
|                                     | > 2018      | 1            | 884BPC1        | 884BPC1-N       |
|                                     |             | 2            | 884BPC2        | 884BPC2-N       |
| CITROEN CAMPSTER - VANSTER          | > 2017      | 1            | 850CV1         | 850CV1-N        |
| CITROEN JUMPY - SPACETOURER         | > 2016      | 1 fixed door | 895SJE0        | 895SJE0-N       |
|                                     |             | 1 open door  | 895SJE1        | 895SJE1-N       |
| FIAT DUCATO                         | 2006 - 2014 | 2            | 805FD2         | 805FD2-N        |
|                                     | > 2015      | 2            | 805FD3         | 805FD3-N        |
| FIAT SCUDO                          | 2006 - 2016 | 1            | 872SJE1        | 872SJE1-N       |
|                                     |             | 2            | 872SJE2        | 872SJE2-N       |
| FORD TRANSIT                        | 2007 - 2014 | 2            | 813FT2         | 813FT2-N        |
|                                     | > 2015      | 2            | 839FT2         | 839FT2-N        |
| FORD CUSTOM                         | 2012 - 2022 | 1 w/wiper    | 843FTC0        | 843FTC0-N       |
|                                     |             | 1 no wiper   | 843FTC1        | 843FTC1-N       |
|                                     | > 2023      | 2            | 843FTC2        | 843FTC2-N       |
|                                     |             | 2            | 844FTC1        | 844FTC1-N       |
| MERCEDES BENZ VITO - VIANO - TOURER | < 2003      | 1            | 818MV1         | 818MV1-N        |
|                                     |             | 2            | 818MV2         | 818MV2-N        |
|                                     | 2004 - 2014 | 1            | 819MV1         | 819MV1-N        |
|                                     |             | 2            | 819MV2         | 819MV2-N        |
|                                     | > 2015      | 1            | 879MV1         | 879MV1-N        |
|                                     |             | 2            | 879MV2         | 879MV2-N        |
| NISSAN NV 200                       | 2009 - 2021 | 1            | 824NV2         | 824NV2-N        |
| RENAULT TRAFIC                      | 2002 - 2014 | 1            | 823RT1         | 823RT1-N        |
|                                     |             | 2            | 823RT2         | 823RT2-N        |
|                                     | > 2015      | 1            | 846RT1         | 846RT1-N        |
|                                     |             | 2            | 846RT2         | 846RT2-N        |
| RENAULT KANGOO                      | 1997 - 2007 | 1            | 824RK0         | 824RK0-N        |
|                                     |             | 2            | 824RK3         | 824RK3-N        |
|                                     | > 2008      | 1            | 840RK0         | 840RK0-N        |
|                                     |             | 2            | 840RK3         | 840RK3-N        |
| VOLKSWAGEN T2 - T3                  | 1979 - 1989 | 1            | 806VW1         | 806VW1-N        |
| VOLKSWAGEN T4                       | 1990 - 2002 | 1            | 807VW1         | 807VW1-N        |
|                                     |             | 2            | 807VW2         | 807VW2-N        |
| VOLKSWAGEN T5 - T6 - T6.1           | 2003 - 2023 | 1 w/wiper    | 808VW0         | 808VW0-N        |
|                                     |             | 1 no wiper   | 808VW1         | 808VW1-N        |
|                                     |             | 1 comfort    | 808VW3         | 808VW3-N        |
|                                     |             | 2            | 808VW2         | 808VW2-N        |
| VOLKSWAGEN MULTIVAN                 | > 2024      | 1            | 809VW1         | 809VW1-N        |
| VOLKSWAGEN TRANSPORTER              | > 2023      | 1            | 844FTC1        | 844FTC1-N       |
|                                     |             | 2            | 844FTC2        | 844FTC2-N       |
| VOLKSWAGEN ID BUZZ                  | > 2023      | 1            | 811VW1         | 811VW1-N        |
| VOLKSWAGEN CADDY                    | 2004 - 2020 | 1            | 844VW0         | 844VW0-N        |
|                                     |             | 2            | 844VW3         | 844VW3-N        |
|                                     | > 2021      | 1            | 845VW1         | 845VW1-N        |

instructions & useful information



# THERMOMAG

Innovative thermal driver's cab for camper vans with magnetic fixation

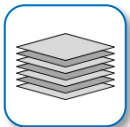

7-layer material



Radiation Reflective



Insulating hot & cold



Eco-friendly product

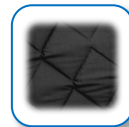

Available in black



Side windows w/magnets



Windscreen secured w/rods

- Fast installation with magnetic fixation and lightweight aluminium rods
- No suction cups needed
- Premium black inner surface with 1st layer made out of 60% of recycled material
- Always fresh material that does not heat up with high temperatures
- Thermal insulation (heat and cold)
- Noise reduction
- Game changer: speed, strong hold, premium look



instructions & useful information



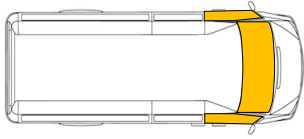

DRIVER'S CAB SET

| VEHICLE                             | YEAR        | ART. CODE |
|-------------------------------------|-------------|-----------|
| CITROEN CAMPSTER - VANSTER          | > 2017      | 701CV     |
| FIAT DUCATO                         | 1993 - 2006 | 702FD     |
|                                     | > 2006      | 703FD     |
| FORD CUSTOM                         | > 2023      | 704FTC    |
| FORD TRANSIT                        | > 2015      | 705FT     |
| MERCEDES BENZ SPRINTER              | > 2006      | 706MS     |
| MERCEDES BENZ VITO - VIANO - TOURER | > 2015      | 707MV     |
| RENAULT TRAFIC                      | 2004 - 2014 | 708RT     |
|                                     | > 2015      | 709RT     |
| VOLKSWAGEN CADDY                    | 2012 - 2020 | 710VW     |
|                                     | > 2021      | 711VW     |
| VOLKSWAGEN CRAFTER                  | 2006 - 2017 | 706MS     |
|                                     | > 2018      | 713VW     |
| VOLKSWAGEN T2 - T3                  | 1979 - 1989 | 714VW     |
| VOLKSWAGEN T4                       | 1990 - 2002 | 715VW     |
| VOLKSWAGEN T5 - T6 - T6.1           | 2003 - 2023 | 716VW     |
| VOLKSWAGEN MULTIVAN                 | > 2021      | 717VW     |
| VOLKSWAGEN TRANSPORTER              | > 2023      | 704FTC    |



# DARKSHADE

## Premium All-Season Internal Thermal Blinds

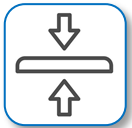
**NEW  
PRODUCT****8 mm  
thickness****Anti-condensation  
fabric****Total  
blackout****Soft and  
lightweight****Fixation with  
suction cups****Double-sided  
grey & black**

Thermo Shield is the ultimate insulation solution for motorhomes and campervans. Designed with a stylish fabric finish, it provides a superior thermal barrier while keeping your interior elegant, comfortable, and private.

- **7-Layer Tech:** Advanced multi-layer insulation for maximum heat reflection and winter warmth.
- **Washable Fabric Interior:** High-quality textile finish in Light Grey or Deep Black. Durable and easy to clean.
- **Total Blackout:** 100% light blockage for complete interior privacy and a restorative sleep.
- **Anti-Condensation:** Engineered to significantly reduce moisture buildup on glass surfaces.
- **Travel Ready:** Includes a practical storage bag for easy stowing and protection.
- **Heavy-Duty Suction Cups:** High-grip, non-marking suckers for a secure and long-lasting fit.

*instructions &  
useful information*



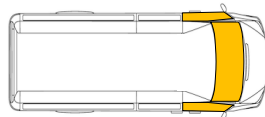

DRIVER'S CAB SET

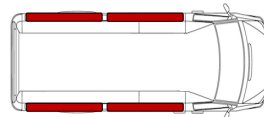

LIVING AREA SET  
short wheelbase

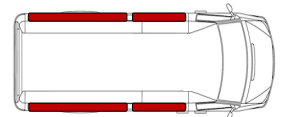

LIVING AREA SET  
long wheelbase

| VEHICLE                    | YEAR        | ART. CODE<br>DRIVER'S CAB 3 PCS | ART. CODE LIVING SPACE<br>5 PCS short step | ART. CODE LIVING SPACE<br>5 PCS long step |
|----------------------------|-------------|---------------------------------|--|---|
| CITROEN CAMPSTER - VANSTER | > 2017      | 500CV                           | 501CV                                      | ---                                       |
| FIAT DUCATO                | 1994 - 2001 | 502FD                           | ---  | ---                                       |
|                            | 2002 - 2005 | 503FD                           | ---  | ---                                       |
|                            | 2006 - 2024 | 504FD                           | ---  | ---                                       |
| FORD CUSTOM                | > 2023      | 505FTC                          | 506FTC                                     | 507FTC                                    |
| MERCEDES-BENZ SPRINTER     | 2006 - 2017 | 508MS                           | ---  | ---                                       |
|                            | > 2018      | 509MS                           | ---  | ---                                       |
| VOLKSWAGEN CADDY           | < 2020      | 510VWCA                         | 511VWCA                                    | 512VWCA                                   |
|                            | > 2021      | 513VWCA                         | 514VWCA                                    | 515VWCA                                   |
| VOLKSWAGEN T4              | 1990 - 2002 | 516VWT4                         | 517VWT4                                    | 518VWT4                                   |
| VOLKSWAGEN T5 - T6 - T6.1  | 2003 - 2023 | 519VWT56                        | 520VWT56                                   | 521VWT56                                  |
| VOLKSWAGEN MULTIVAN        | > 2021      | 522VWM                          | 523VWM                                     | 524VWM                                    |
| VOLKSWAGEN TRANSPORTER     | > 2023      | 505FTC                          | 506FTC                                     | 507FTC                                    |
| VOLKSWAGEN ID BUZZ         | > 2023      | 525VWIB                         | 526VWIB                                    | 527VWIB                                   |
| VOLKSWAGEN CRAFTER         | > 2017      | 528VWCR                         | ---  | ---                                       |

## INTERNAL BLINDS

Thermo-Shield for Seitz-Dometic®

# THERMO-SHIELD

For Seitz-Dometic® S3 / S4 / S5 panels

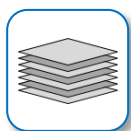

7-layer material



Radiation Reflective



Insulating hot & cold

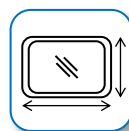

Various measurements available



Fixation with suction cups



Grey color

| Cutout Window<br>W x H (mm) | ART. CODE |
|-----------------------------|-----------|
| mm 1450 X 600               | 4001OTI   |
| mm 1450 X 550               | 4018OTI   |
| mm 1300 X 600               | 4002OTI   |
| mm 1300 X 550               | 4019OTI   |
| mm 1200 X 600               | 4003OTI   |
| mm 1200 X 500               | 4020OTI   |
| mm 1200 X 350               | 4004OTI   |
| mm 1200 X 300               | 4005OTI   |
| mm 1100 X 550               | 4021OTI   |
| mm 1100 X 450               | 4022OTI   |
| mm 1000 X 600               | 4006OTI   |
| mm 1000 X 550               | 4023OTI   |
| mm 1000 X 500               | 4007OTI   |
| mm 1000 X 450               | 4024OTI   |
| mm 900 X 600                | 4008OTI   |
| mm 900 X 550                | 4009OTI   |
| mm 900 X 500                | 4010OTI   |
| mm 900 X 450                | 4017OTI   |
| mm 900 X 400                | 4025OTI   |
| mm 800 X 450                | 4026OTI   |
| mm 750 X 600                | 4011OTI   |
| mm 750 X 400                | 4012OTI   |
| mm 700 X 600                | 4013OTI   |
| mm 700 X 550                | 4027OTI   |
| mm 700 X 450                | 4028OTI   |
| mm 700 X 400                | 4014OTI   |
| mm 700 X 300                | 4015OTI   |
| mm 650 X 300                | 4029OTI   |
| mm 600 X 600                | 4030OTI   |
| mm 600 X 500                | 4031OTI   |
| mm 550 X 600                | 4016OTI   |
| mm 550 X 580                | 4032OTI   |
| mm 500 X 600                | 4033OTI   |
| mm 500 X 450                | 4034OTI   |
| mm 500 X 350                | 4035OTI   |
| mm 500 X 300                | 4036OTI   |
| mm 350 X 500                | 4037OTI   |



instructions &  
useful information



# DO-IT-YOURSELF KIT

The kit that offers the possibility of creating your own thermal blind



**7-layer material**



**Radiation Reflective**



**Insulating hot & cold**



**Fixation with suction cups**



**Available in grey or black**

In the kit you will find:

- 3,5 m x 1,55 m of insulating material (grey or black color)
- 30 suction cups (grey or black color)
- 30 plastic eyelets
- 30 m hem material (white/grey or grey/black color)
- 1 plastic sheet to prepare the template
- 1 practical TNT bag (blue or black color)
- The instructions for how to create your thermal blind

## GREY KIT



## BLACK KIT



# COVER-THERM

A perfect second skin for the exterior of your camper van



**8 mm thickness**

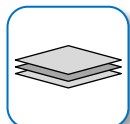

**3-layer material**



**Insulating hot & cold**



**Velcro felt to anchor the engine part**



**Hook to the anchor the vehicle**

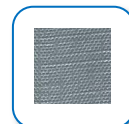

**Available in grey**

- Covering the vehicle from the outside, you eliminate the humid interior air: no more annoying drops of water that drips onto the dashboard.
- The cabin protection provides absolute privacy blocking out all external light.
- The thermal blind acts as a protective shield from direct sunlight and UV rays.
- Practical storage: they are sold with a dedicated carry bag.
- Being made of waterproof and synthetic materials, a simple wipe with a sponge is enough to remove dirt.

instructions & useful information

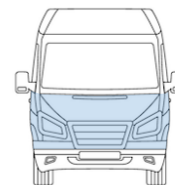
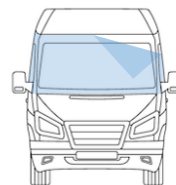
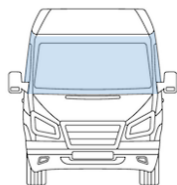

| VEHICLE                                  | YEAR    | Driver's cab ART. CODE | Driver's cab with velcro ART. CODE | Engine hood ART. CODE |
|--|---------|------------------------|------------------------------------|-----------------------|
| CITROEN CAMPSTER - VANSTER - SPACETOURER | > 2016  | -                      | 924CV-V                            | -                     |
| FIAT DUCATO                              | 94 - 01 | 907FD1                 | 907FD1-V                           | 950FDM1               |
|  | 02 - 05 | 908FD2                 | 908FD2-V                           | 951FDM2               |
|  | 06 - 14 | 916FD4                 | 916FD4-V                           | 952FDM3               |
|  | > 2015  |                        |                                    | 963FDM4               |
| FORD TRANSIT                             | 86 - 94 | 914FT4                 | 914FT4-V                           | 961FTM3               |
|  | 95 - 99 | 914FT3                 | 914FT3-V                           |                       |
|  | 00 - 06 | 910FT1                 | 910FT1-V                           | 953FTM1               |
|  | 07 - 14 | 911FT2                 | 911FT2-V                           | 954FTM2               |
| FORD CUSTOM                              | > 2015  | 915FT4                 | 915FT4-V                           | 962FTM4               |
|  | 12 - 22 | 919FTC5                | 919FTC5-V                          | 968FCM5               |
|  | > 2023  | 921FTC6                | 921FTC6-V                          | 969FTC6               |
| IVECO DAILY                              | 00 - 06 | 903EIV1                | 903EIV1-V                          | 955IVM1               |
|  | 07 - 14 | 904EIV2                | 904EIV2-V                          | 956IVM2               |
|  | > 2015  | 917IV3                 | 917IV3-V                           | 964IVM3               |
| MERCEDES-BENZ SPRINTER                   | 96 - 05 | 905MS1                 | 905MS1-V                           | 957MSM1               |
|  | 06 - 14 | 906MS2                 | 906MS2-V                           | 958MSM2               |
|  | > 2015  | 918MS3                 | 918MS3-V                           | 965MSM3               |
| MERCEDES BENZ VITO - VIANO - TOURER      | > 2015  | -                      | 925MV4-V                           | -                     |
| RENAULT MASTER                           | 05 - 10 | 912RM                  | 912RM-V                            | 959RMM1               |
|  | > 2011  | 913RM2                 | 913RM2-V                           | 960RMM2               |
| RENAULT TRAFIC                           | > 2015  | -                      | 926RM3-V                           | -                     |
| VOLKSWAGEN CADDY                         | > 2021  | 923VWC1                | 923VWC1-V                          | 971VWC1               |
| VOLKSWAGEN MULTIVAN                      | > 2021  | 922EM1                 | 922EM1-V                           | 970EM1                |
| VOLKSWAGEN T4                            | 90 - 03 | 901ET4                 | 901ET4-V                           | -                     |
| VOLKSWAGEN T5 - T6 - T6.1                | 03 - 23 | 902ET5                 | 902ET5-V                           | 967T6M                |
| VOLKSWAGEN TRANSPORTER                   | > 2023  | 921FTC6                | 921FTC6-V                          | 969FTC6               |

# COVERTECH EVOLUTION

The *premium* external blind: a perfect thermal coat for your camper van

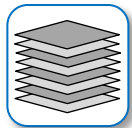

**8-layer material**



**Insulating extreme temperatures hot & cold**



**Velcro felt to anchor the engine part**



**Premium suction cups included**  
*(for motorhome vehicles)*



**Available in grey**

instructions & useful information



- Made of extremely soft but at the same time very resistant material.
- The engine protection helps providing snow or rain from accumulating in the windshield wiper mechanisms or blocking the air vents.
- The thermal blind acts as a protective shield from direct sunlight and UV rays.
- The covers are kept in eco-leather bags: practical, beautiful and resistant.
- For motorhomes, 4 suction cups are used for the application, which are aesthetically very beautiful and at the same time very functional (tested at extreme temperatures).

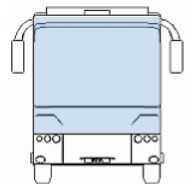
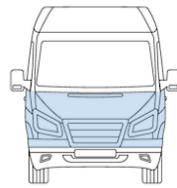
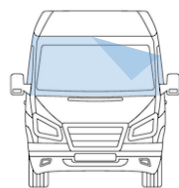

| VEHICLE                   | YEAR    | Driver's cab ART. CODE | Engine hood ART. CODE |
|---------------------------|---------|------------------------|-----------------------|
| FIAT DUCATO               | 94 - 01 | LUXFD1C                | LUXFD1V               |
|                           | 02 - 05 | LUXFD2C                | LUXFD2V               |
|                           | 06 - 14 | LUXFD4C                | LUXFD3V               |
|                           | 15 - 24 |                        | LUXFD4V               |
| FORD TRANSIT              | 86 - 94 | LUXFT3C                | LUXFT4V               |
|                           | 95 - 99 | LUXFT4C                |                       |
|                           | 00 - 06 | LUXFT1C                | LUXFT1V               |
|                           | 07 - 14 | LUXFT2C                | LUXFT2V               |
|                           | > 2015  | LUXFT5C                | LUXFT3V               |
| IVECO DAILY               | 00 - 06 | LUXIV1C                | LUXIV1V               |
|                           | 07 - 14 | LUXIV2C                | LUXIV2V               |
| MERCEDES BENZ SPRINTER    | 96 - 05 | LUXMS1C                | LUXMS1V               |
|                           | 06 - 14 | LUXMS2C                | LUXMS2V               |
|                           | > 2015  | LUXMS3C                | LUXMS3V               |
| RENAULT MASTER            | 05 - 10 | LUXRM1C                | LUXRM1V               |
|                           | > 2011  | LUXRM2C                | LUXRM2V               |
| VOLKSWAGEN T4             | 90 - 03 | LUXVW1                 | -                     |
| VOLKSWAGEN T5 - T6 - T6.1 | 03 - 23 | LUXVW2                 | -                     |

| VEHICLE                   | YEAR               | Motorhome ART. CODE |
|---------------------------|--------------------|---------------------|
| BAVARIA                   | -                  | LUXMB               |
| BURSTNER AVIANO           | -                  | LUXMBA              |
| CARTHAGO C-LINE C-TOURER  | < 2011             | LUXMC               |
|                           | 12 - 22            | LUXMC2              |
| CARTHAGO S-PLUS HIGH-LINE | < 2011             | LUXMCP              |
|                           | 12 - 22            | LUXMCP2             |
| MC LUIS ELNAGH            | < 2015 low mirror  | LUXME               |
|                           | > 2016 high mirror | LUXME2              |
| MOBILVETTA                | < 2015 low mirror  | LUXMM               |
|                           | > 2016 high mirror | LUXMM2              |
| PILOTE                    | M1 - M3            | LUXMP               |
|                           | M4                 | LUXMP2              |
| RAPIDO                    | High mirror        | LUXMR               |
|                           | Low mirror         | LUXMR1              |

## EXTERNAL BLINDS

Cover-Therm for Seitz-Dometic®

# COVER-THERM

For Seitz-Dometic® S3 / S4 / S5 panels

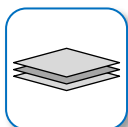

**3-layer material**



**Insulating hot & cold**

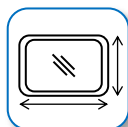

**Various measurements available**



**Anchoring with buckle & elastic band**

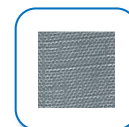

**Grey color**

| Cutout Window<br>W x H (mm) | ART. CODE |
|-----------------------------|-----------|
| mm 1450 X 600               | 4001OTE   |
| mm 1450 X 550               | 4018OTE   |
| mm 1300 X 600               | 4002OTE   |
| mm 1300 X 550               | 4019OTE   |
| mm 1200 X 600               | 4003OTE   |
| mm 1200 X 500               | 4020OTE   |
| mm 1200 X 350               | 4004OTE   |
| mm 1200 X 300               | 4005OTE   |
| mm 1100 X 550               | 4021OTE   |
| mm 1100 X 450               | 4022OTE   |
| mm 1000 X 600               | 4006OTE   |
| mm 1000 X 550               | 4023OTE   |
| mm 1000 X 500               | 4007OTE   |
| mm 1000 X 450               | 4024OTE   |
| mm 900 X 600                | 4008OTE   |
| mm 900 X 550                | 4009OTE   |
| mm 900 X 500                | 4010OTE   |
| mm 900 X 450                | 4017OTE   |
| mm 900 X 400                | 4025OTE   |
| mm 800 X 450                | 4026OTE   |
| mm 750 X 600                | 4011OTE   |
| mm 750 X 400                | 4012OTE   |
| mm 700 X 600                | 4013OTE   |
| mm 700 X 550                | 4027OTE   |
| mm 700 X 450                | 4028OTE   |
| mm 700 X 400                | 4014OTE   |
| mm 700 X 300                | 4015OTE   |
| mm 650 X 300                | 4029OTE   |
| mm 600 X 600                | 4030OTE   |
| mm 600 X 500                | 4031OTE   |
| mm 550 X 600                | 4016OTE   |
| mm 550 X 580                | 4032OTE   |
| mm 500 X 600                | 4033OTE   |
| mm 500 X 450                | 4034OTE   |
| mm 500 X 350                | 4035OTE   |
| mm 500 X 300                | 4036OTE   |
| mm 350 X 500                | 4037OTE   |



*instructions &  
useful information*



# ROLLS OF FABRIC

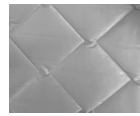

GREY COLOR

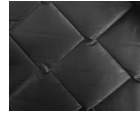

BLACK COLOR



7-LAYERS



9-LAYERS

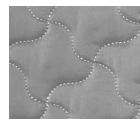
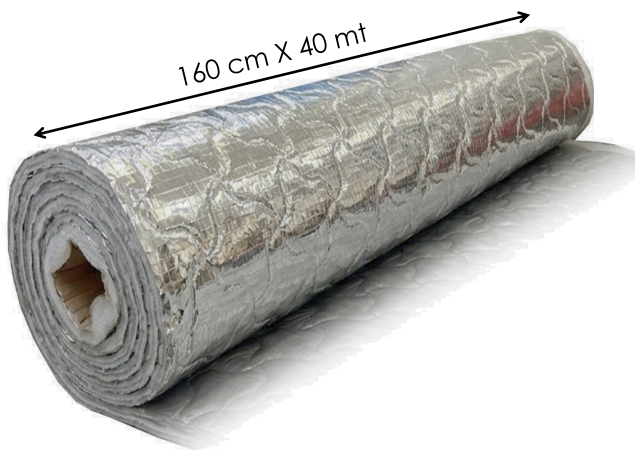

GREY COLOR



BLACK COLOR



7-LAYERS

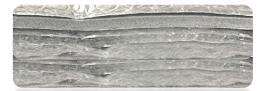

9-LAYERS

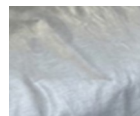

GREY COLOR



8-LAYERS

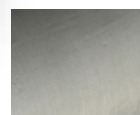
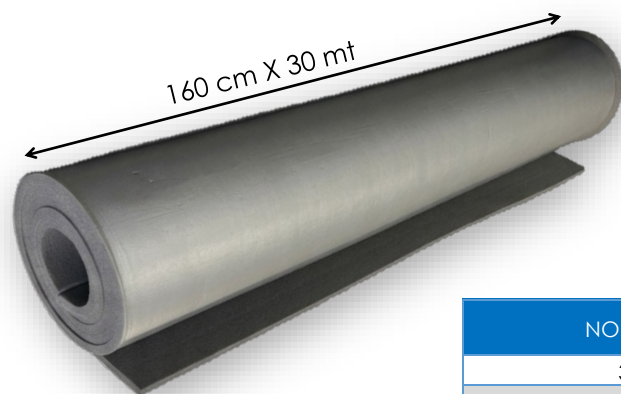

GREY COLOR



3-LAYERS

| NO. OF LAYERS | QUILTING STYLE | COLOR | ART. CODE |
|---------------|----------------|-------|-----------|
| 3-layers      | -              | grey  | 897TP     |
| 7-layers      | Square design  | grey  | 899TT     |
|               |                | black | 899TT1    |
|               | Star design    | grey  | 899TT4    |
|               |                | black | 899TT5    |
| 8-layers      | -              | grey  | 896T8     |
| 9-layers      | Square design  | grey  | 900T9     |
|               |                | black | 900T91    |
|               | Star design    | grey  | 900T94    |
|               |                | black | 900T95    |

# MAG-NETS

Mosquito-nets for driver's cab windows and for sliding & rear doors

**NEW PRODUCT**



**Easy & fast installation**



**Protection against insects**



**UV resistant polyester fabrics**

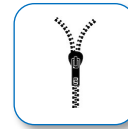

**Closure with zipper**  
(for lateral & rear doors)



**Attachment to vehicle with magnets**

- Fast installation with magnetic fixation.
- It ensures air circulation without letting in unwanted insects, pollen, or dust.
- Unlike a closed door, the mosquito net allows you to enjoy the view and natural light while remaining protected inside.
- They offer a certain degree of privacy: you can see outside clearly, but passersby struggle to see the details inside the van.

instructions & useful information

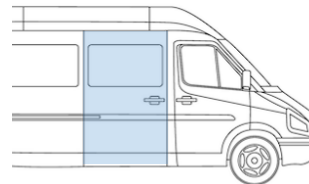
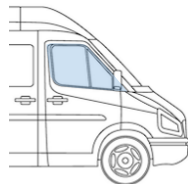

| VEHICLE                     | YEAR    | Driver's cab windows<br>Left & Right ART. CODE | Lateral sliding door<br>ART. CODE | Rear openable door<br>ART. CODE |
|-----------------------------|---------|--|-----------------------------------|---------------------------------|
| CITROEN JUMPY - SPACETOURER | > 2017  | 701ZFM   | 701ZSM                            | 701ZPM                          |
| FIAT DUCATO                 | > 2006  | 702ZFM   | 702ZSM                            | 702ZPM                          |
| FORD CUSTOM                 | 12 - 22 | 703ZFM   | 703ZSM                            | 703ZPM                          |
|                             | > 2023  | 704ZFM   | 704ZSM                            | 704ZPM                          |
| FORD TRANSIT                | > 2014  | 705ZFM   | 705ZSM                            | 705ZPM                          |
| MERCEDES-BENZ SPRINTER      | 06 - 17 | 706ZFM   | 706ZSM                            | 706ZPM                          |
|                             | > 2018  | 707ZFM   | 707ZSM                            | 707ZPM                          |
| MERCEDES-BENZ VITO - VIANO  | > 2003  | 708ZFM   | 708ZSM                            | 708ZPM                          |
| RENAULT MASTER              | 10 - 20 | 709ZFM   | 709ZSM                            | 709ZPM                          |
| RENAULT TRAFIC              | > 2014  | 710ZFM   | 710ZSM                            | 710ZPM                          |
| VOLKSWAGEN CRAFTER          | > 2017  | 711ZFM   | 711ZSM                            | 711ZPM                          |
| VOLKSWAGEN CADDY            | 03 - 20 | 712ZFM   | 712ZSM                            | 712ZPM                          |
|                             | > 2021  | 713ZFM   | 713ZSM                            | 713ZPM                          |
| VOLKSWAGEN T4               | 90 - 02 | 714ZFM   | 714ZSM                            | 714ZPM                          |
| VOLKSWAGEN T5-T6            | 03 - 24 | 715ZFM   | 715ZSM                            | 715ZPM                          |
| VOLKSWAGEN MULTIVAN         | > 2023  | 716ZFM   | 716ZSM                            | 716ZPM                          |
| VOLKSWAGEN ID BUZZ          | > 2023  | 717ZFM   | 717ZSM                            | 717ZPM                          |

# AIRVAN

Maximum ventilation, minimum effort: your essential accessory



**Simple assembly**



**Rubber edging for perfect sealing**



**Scratchproof material**



**Shockproof material**

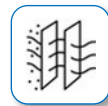

**Constant air flow**



**Effective insect protection**



**Effective rain protection**



**Material: polycarbonate**

- It's easy to assemble thanks to its rear rails that fit perfectly to the vehicle.
- Lightweight and easy to handle, yet durable and effective.
- It is made of a shockproof and scratchproof painted polycarbonate material.
- Each grille has a built-in mosquito net that functions as a very effective insect protection.
- It is structured in such a way that no water can penetrate through its ventilation slats even when it's raining.

instructions & useful information



| VEHICLE            | YEAR               | MODEL                   | ART. CODE  |
|--------------------|--------------------|-------------------------|------------|
| FIAT DUCATO        | > 2007             | Driver, left window     | AIRVAN3018 |
|                    |                    | Passenger, right window | AIRVAN3017 |
| FIAT SCUDO         | 06 - 16            | Driver, left window     | AIRVAN3016 |
|                    |                    | Passenger, right window | AIRVAN3015 |
| FIAT TALENTO       | > 2004             | Driver, left window     | AIRVAN3014 |
|                    |                    | Passenger, right window | AIRVAN3013 |
| RENAULT TRAFIC     | > 2014             | Driver, left window     | AIRVAN3020 |
|                    |                    | Passenger, right window | AIRVAN3019 |
| VOLKSWAGEN T4      | 90 - 02 short step | Driver, left window     | AIRVAN3012 |
|                    |                    | Passenger, right window | AIRVAN3011 |
|                    | 90 - 02 long step  | Driver, left window     | AIRVAN3010 |
|                    |                    | Passenger, right window | AIRVAN3009 |
| VOLKSWAGEN T5 - T6 | 03 - 19            | Driver, left window     | AIRVAN3006 |
|                    |                    | Passenger, right window | AIRVAN3005 |
| VOLKSWAGEN T6.1    | > 2019             | Driver, left window     | AIRVAN3004 |
|                    |                    | Passenger, right window | AIRVAN3003 |

# WINDOW REPLACEMENT PANELS

Europa Model

## EUROPA MODEL

Panel compatible with Parapress® & Polyplastic® up to year 2000



**PMMA panel**



**Double glass**



**Hinge included**



**Certified window**



| Cutout Dimension W x H (mm) | Grey    | Opaque Grey | Bronze  | Opaque Bronze |
|-----------------------------|---------|-------------|---------|---------------|
|                             | Art. No | Art. No     | Art. No | Art. No       |
| 1767x800                    | 1048AG  | ---         | 1048AB  | ---           |
| 1600x720                    | 1041AG  | ---         | 1041AB  | ---           |
| 1600x670                    | 2001EG  | ---         | 2001EB  | ---           |
| 1600x600                    | 160X60G | ---         | 160X60B | ---           |
| 1600x550                    | 2002EG  | ---         | 2002EB  | ---           |
| 1600x300                    | 160X30G | ---         | 160X30B | ---           |
| 1550x730                    | 1047AG  | ---         | 1047AB  | ---           |
| 1550x650                    | 2003EG  | ---         | 2003EB  | ---           |
| 1505x550                    | 150X55G | ---         | 150X55B | ---           |
| 1500x750                    | 1035AG  | ---         | 1035AB  | ---           |
| 1500x700                    | 1025AG  | ---         | 1025AB  | ---           |
| 1500x630                    | 1052AG  | ---         | 1052AB  | ---           |
| 1500x600                    | 1042AG  | ---         | 1042AB  | ---           |
| 1500x550                    | 2004EG  | ---         | 2004EB  | ---           |
| 1470x700                    | 1024AG  | ---         | 1024AB  | ---           |
| 1450x600                    | 2005EG  | ---         | 2005EB  | ---           |
| 1450x550                    | 1001AG  | ---         | 1001AB  | ---           |
| 1400x720                    | 1040AG  | ---         | ---     | ---           |
| 1400x650                    | 1023AG  | ---         | 1023AB  | ---           |
| 1400x600                    | 2007EG  | ---         | 2007EB  | ---           |
| 1350x780                    | 1046AG  | ---         | 1046AB  | ---           |
| 1350x730                    | 1045AG  | ---         | 1045AB  | ---           |
| 1340x650                    | 1027AG  | ---         | 1027AB  | ---           |
| 1300x650                    | 2009EG  | ---         | 2009EB  | ---           |
| 1300x600                    | 1022AG  | ---         | 1022AB  | ---           |
| 1300x550                    | 1002AG  | ---         | 1002AB  | ---           |
| 1250x300                    | 2011EG  | ---         | 2011EB  | ---           |
| 1200x650                    | 1021AG  | ---         | 1021AB  | ---           |
| 1200x600                    | 1050AG  | ---         | 1050AB  | ---           |
| 1200x550                    | 2012EG  | ---         | 2012EB  | ---           |
| 1200x520                    | 1010AG  | ---         | 1010AB  | ---           |
| 1200x500                    | 2013EG  | ---         | 2013EB  | ---           |
| 1200x460                    | 2014EG  | ---         | 2014EB  | ---           |
| 1200x300                    | 1003AG  | ---         | 1003AB  | ---           |
| 1100x550                    | 1049AG  | ---         | 1049AB  | ---           |
| 1020x600                    | 1020AG  | ---         | 1020AB  | ---           |
| 1000x600                    | 2016EG  | ---         | 2016EB  | ---           |
| 1000x550                    | 2017EG  | ---         | 2017EB  | ---           |
| 1000x530                    | 1044AG  | ---         | 1044AB  | ---           |
| 1000x500                    | 1004AG  | ---         | 1004AB  | ---           |
| 1000x300                    | 100X30G | ---         | 100X30B | ---           |
| 990x630                     | 2019EG  | ---         | 2019EB  | ---           |
| 980x250                     | 2046EG  | ---         | ---     | ---           |
| 954x494                     | 1031AG  | ---         | 1031AB  | ---           |

| Cutout Dimension W x H (mm) | Grey    | Opaque Grey | Bronze  | Opaque Bronze |
|-----------------------------|---------|-------------|---------|---------------|
|                             | Art. No | Art. No     | Art. No | Art. No       |
| 950x550                     | 1043AG  | ---         | 1043AB  | ---           |
| 900x650                     | 1019AG  | ---         | 1019AB  | ---           |
| 900x600                     | 1051AG  | ---         | 1051AB  | ---           |
| 900x550                     | 2020EG  | ---         | 2020EB  | ---           |
| 900x520                     | 1018AG  | ---         | 1018AB  | ---           |
| 900x500                     | 1005AG  | ---         | 1005AB  | ---           |
| 900x460                     | 2022EG  | ---         | 2022EB  | ---           |
| 900x450                     | 1029AG  | ---         | 1029AB  | ---           |
| 900x300                     | 900X30G | ---         | 900X30B | ---           |
| 870x700                     | 1017AG  | ---         | 1017AB  | ---           |
| 870x650                     | 1016AG  | ---         | 1016AB  | ---           |
| 870x600                     | 1036AG  | ---         | 1036AB  | ---           |
| 870x520                     | 1015AG  | ---         | 1015AB  | ---           |
| 870x500                     | 1014AG  | ---         | 1014AB  | ---           |
| 800x950                     | 1037AG  | ---         | 1037AB  | ---           |
| 800x900                     | 1032AG  | ---         | 1032AB  | ---           |
| 800x550                     | 2023EG  | ---         | 2023EB  | ---           |
| 800x460                     | 2024EG  | ---         | 2024EB  | ---           |
| 800x450                     | 1006AG  | ---         | 1006AB  | ---           |
| 800x350                     | 2025EG  | ---         | 2025EB  | ---           |
| 780x600                     | 1030AG  | ---         | 1030AB  | ---           |
| 780x450                     | 1028AG  | ---         | 1028AB  | ---           |
| 720x320                     | 2026EG  | ---         | 2026EB  | ---           |
| 700x550                     | 2027EG  | ---         | 2027EB  | ---           |
| 700x520                     | 1013AG  | ---         | 1013AB  | ---           |
| 700x500                     | 2028EG  | ---         | 2028EB  | ---           |
| 700x460                     | 2029EG  | ---         | 2029EB  | ---           |
| 700x400                     | 1038AG  | ---         | 1038AB  | ---           |
| 700x350                     | 2030EG  | ---         | 2030EB  | ---           |
| 700x300                     | 1007AG  | ---         | 1007AB  | ---           |
| 650x900                     | 1026AG  | ---         | 1026AB  | ---           |
| 600x550                     | 1011AG  | 1011AGO     | 1011AB  | 1011ABO       |
| 600x250                     | 2033EG  | ---         | 2033EB  | ---           |
| 550x550                     | 1008AG  | 1008AGO     | 1008AB  | 1008ABO       |
| 550x350                     | 2035EG  | 2035EGO     | 2035EB  | 2035EBO       |
| 500x650                     | 2036EG  | 2036EGO     | 2036EB  | 2036EBO       |
| 500x550                     | 2037EG  | 2037EGO     | 2037EB  | 2037EBO       |
| 500x520                     | 1012AG  | 1012AGO     | 1012AB  | 1012ABO       |
| 460x460                     | 1009AG  | 1009AGO     | 1009AB  | 1009ABO       |
| 450x550                     | 2039EG  | 2039EGO     | 2039EB  | 2039EBO       |
| 400x550                     | 2040EG  | 2040EGO     | 2040EB  | 2040EBO       |
| 350x550                     | 2044EG  | 2044EGO     | 2044EB  | 2044EBO       |
| 350x500                     | 2045EG  | 2045EGO     | 2045EB  | 2045EBO       |

# DOUBLE GLAZED MODEL

The professional choice for Seitz-Dometic® S3 / S4 / S5 & MS5 panels



**PMMA panel**

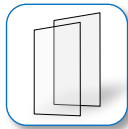

**Double glass**



**Hinge included**



**Certified window**



useful information



| Cutout Window W x H (mm) | Outer Dimension Acrylic glass W x H (mm) | Grey<br>(compatible with S4 - S5 panels) | Bronze<br>(compatible with S3 panels) | Dark<br>(compatible with MS5 panels) |
|--------------------------|--|--|---------------------------------------|--------------------------------------|
|                          |  | Art. No                                  | Art. No                               | Art. No                              |
| 1450x600                 | 1418x534                                 | 40011G                                   | 40011B                                | 40011A                               |
| 1450x550                 | 1418x484                                 | 40181G                                   | 40181B                                | 40181A                               |
| 1300x600                 | 1268x534                                 | 40021G                                   | 40021B                                | 40021A                               |
| 1300x550                 | 1268x484                                 | 40191G                                   | 40191B                                | 40191A                               |
| 1200x600                 | 1168x534                                 | 40031G                                   | 40031B                                | 40031A                               |
| 1200x500                 | 1168x434                                 | 40201G                                   | 40201B                                | 40201A                               |
| 1200x350                 | 1168x282                                 | 40041G                                   | 40041B                                | 40041A                               |
| 1200x300                 | 1168x232                                 | 40051G                                   | 40051B                                | 40051A                               |
| 1100x550                 | 1068x484                                 | 40211G                                   | 40211B                                | 40211A                               |
| 1100x450                 | 1068x382                                 | 40221G                                   | 40221B                                | 40221A                               |
| 1000x600                 | 968x534                                  | 40061G                                   | 40061B                                | 40061A                               |
| 1000x550                 | 968x484                                  | 40231G                                   | 40231B                                | 40231A                               |
| 1000x500                 | 968x434                                  | 40071G                                   | 40071B                                | 40071A                               |
| 1000x450                 | 968x380                                  | 40241G                                   | 40241B                                | 40241A                               |
| 900x600                  | 868x534                                  | 40081G                                   | 40081B                                | 40081A                               |
| 900x550                  | 868x484                                  | 40091G                                   | 40091B                                | 40091A                               |
| 900x500                  | 868x434                                  | 40101G                                   | 40101B                                | 40101A                               |
| 900x450                  | 868x382                                  | 40171G                                   | 40171B                                | 40171A                               |
| 900x400                  | 868x334                                  | 40251G                                   | 40251B                                | 40251A                               |
| 800x450                  | 768x382                                  | 40261G                                   | 40261B                                | 40261A                               |
| 800x350                  | 768x282                                  | 40391G                                   | ---                                   | 40391A                               |
| 750x600                  | 718x534                                  | 40111G                                   | 40111B                                | 40111A                               |
| 750x400                  | 718x332                                  | 40121G                                   | 40121B                                | 40121A                               |
| 700x600                  | 668x534                                  | 40131G                                   | 40131B                                | 40131A                               |
| 700x550                  | 668x484                                  | 40271G                                   | 40271B                                | 40271A                               |
| 700x500                  | 668x434                                  | 40401G                                   | ---                                   | 40401A                               |
| 700x450                  | 668x382                                  | 40281G                                   | 40281B                                | 40281A                               |
| 700x400                  | 668x332                                  | 40141G                                   | 40141B                                | 40141A                               |
| 700x350                  | 668x282                                  | 40381G                                   | ---                                   | 40381A                               |
| 700x300                  | 668x232                                  | 40151G                                   | 40151B                                | 40151A                               |
| 650x300                  | 618x232                                  | 40291G                                   | 40291B                                | 40291A                               |
| 600x600                  | 568x534                                  | 40301G                                   | 40301B                                | 40301A                               |
| 600x500                  | 568x434                                  | 40311G                                   | 40311B                                | 40311A                               |
| 550x600                  | 518x534                                  | 40161G                                   | 40161B                                | 40161A                               |
| 550x580                  | 518x512                                  | 40321G                                   | 40321B                                | 40321A                               |
| 550x550                  | 518x484                                  | 40411G                                   | ---                                   | 40411A                               |
| 500x600                  | 468x534                                  | 40331G                                   | 40331B                                | 40331A                               |
| 500x450                  | 468x380                                  | 40341G                                   | 40341B                                | 40341A                               |
| 500x350                  | 468x282                                  | 40351G                                   | 40351B                                | 40351A                               |
| 500x300                  | 468x232                                  | 40361G                                   | 40361B                                | 40361A                               |
| 350x500                  | 318x434                                  | 40371G                                   | 40371B                                | 40371A                               |

\* Outer frame not included, image for illustrative purposes only.

# WINDOW REPLACEMENT PANELS

Africa Model

## AFRICA MODEL

Panel compatible with Parapress® & Polyplastic® from year 2000 on



PMMA panel

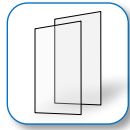

Double glass



Hinge & counter hinge included



Certified window



| Cutout Dimension W x H (mm) | Grey       | Bronze     | Dark       |
|-----------------------------|------------|------------|------------|
|                             | Art. No    | Art. No    | Art. No    |
| 1450x650                    | AFRICA101G | AFRICA101M | AFRICA101A |
| 1450x600                    | AFRICA102G | AFRICA102M | AFRICA102A |
| 1450x550                    | AFRICA103G | AFRICA103M | AFRICA103A |
| 1300x550                    | AFRICA104G | AFRICA104M | AFRICA104A |
| 1300x380                    | AFRICA124G | AFRICA124M | AFRICA124A |
| 1200x520                    | AFRICA105G | AFRICA105M | AFRICA105A |
| 1250x300                    | AFRICA106G | AFRICA106M | AFRICA106A |
| 1200x300                    | AFRICA107G | AFRICA107M | AFRICA107A |
| 1000x600                    | AFRICA108G | AFRICA108M | AFRICA108A |
| 1000x550                    | AFRICA109G | AFRICA109M | AFRICA109A |
| 900x840                     | AFRICA123G | AFRICA123M | AFRICA123A |
| 900x550                     | AFRICA110G | AFRICA110M | AFRICA110A |
| 900x500                     | AFRICA111G | AFRICA111M | AFRICA111A |
| 900x450                     | AFRICA112G | AFRICA112M | AFRICA112A |
| 900x350                     | AFRICA113G | AFRICA113M | AFRICA113A |
| 800x550                     | AFRICA114G | AFRICA114M | AFRICA114A |
| 800x400                     | AFRICA115G | AFRICA115M | AFRICA115A |
| 700x500                     | AFRICA116G | AFRICA116M | AFRICA116A |
| 700x350                     | AFRICA117G | AFRICA117M | AFRICA117A |
| 700x300                     | AFRICA118G | AFRICA118M | AFRICA118A |
| 600x550                     | AFRICA119G | AFRICA119M | AFRICA119A |
| 550x550                     | AFRICA120G | AFRICA120M | AFRICA120A |
| 500x500                     | AFRICA121G | AFRICA121M | AFRICA121A |
| 350x550                     | AFRICA122G | AFRICA122M | AFRICA122A |

# ASIA MODEL

Panel compatible with Parapress® & Polyplastic® from year 2000 on



**PMMA panel**



**Double glass**



**Hinge & counter hinge included**



**Certified window**



*useful information*



| Cutout Dimension<br>W x H (mm) | Grey     | Bronze   | Dark     |
|--------------------------------|----------|----------|----------|
|                                | Art. No  | Art. No  | Art. No  |
| 1450x650                       | ASIA201G | ASIA201M | ASIA201A |
| 1450x600                       | ASIA202G | ASIA202M | ASIA202A |
| 1450x550                       | ASIA203G | ASIA203M | ASIA203A |
| 1300x550                       | ASIA204G | ASIA204M | ASIA204A |
| 1300x380                       | ASIA224G | ASIA224M | ASIA224A |
| 1200x520                       | ASIA205G | ASIA205M | ASIA205A |
| 1250x300                       | ASIA206G | ASIA206M | ASIA206A |
| 1200x300                       | ASIA207G | ASIA207M | ASIA207A |
| 1000x600                       | ASIA208G | ASIA208M | ASIA208A |
| 1000x550                       | ASIA209G | ASIA209M | ASIA209A |
| 900x840                        | ASIA223G | ASIA223M | ASIA223A |
| 900x550                        | ASIA210G | ASIA210M | ASIA210A |
| 900x500                        | ASIA211G | ASIA211M | ASIA211A |
| 900x450                        | ASIA212G | ASIA212M | ASIA212A |
| 900x350                        | ASIA213G | ASIA213M | ASIA213A |
| 800x550                        | ASIA214G | ASIA214M | ASIA214A |
| 800x400                        | ASIA215G | ASIA215M | ASIA215A |
| 700x500                        | ASIA216G | ASIA216M | ASIA216A |
| 700x350                        | ASIA217G | ASIA217M | ASIA217A |
| 700x300                        | ASIA218G | ASIA218M | ASIA218A |
| 600x550                        | ASIA219G | ASIA219M | ASIA219A |
| 550x550                        | ASIA220G | ASIA220M | ASIA220A |
| 500x500                        | ASIA221G | ASIA221M | ASIA221A |
| 350x550                        | ASIA222G | ASIA222M | ASIA222A |

# WINDOW REPLACEMENT PANELS

Oceania Model

## OCEANIA MODEL

Panel compatible with Parapress® & Polyplastic® from year 2000 on



PMMA panel

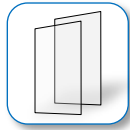

Double glass



Hinge & counter hinge included



Certified window



useful information



| Cutout Dimension<br>W x H (mm) | Grey        | Bronze      | Dark        |
|--------------------------------|-------------|-------------|-------------|
|                                | Art. No     | Art. No     | Art. No     |
| 1450x650                       | OCEANIA301G | OCEANIA301M | OCEANIA301A |
| 1450x600                       | OCEANIA302G | OCEANIA302M | OCEANIA302A |
| 1450x550                       | OCEANIA303G | OCEANIA303M | OCEANIA303A |
| 1300x550                       | OCEANIA304G | OCEANIA304M | OCEANIA304A |
| 1300x380                       | OCEANIA324G | OCEANIA324M | OCEANIA324A |
| 1200x520                       | OCEANIA305G | OCEANIA305M | OCEANIA305A |
| 1250x300                       | OCEANIA306G | OCEANIA306M | OCEANIA306A |
| 1200x300                       | OCEANIA307G | OCEANIA307M | OCEANIA307A |
| 1000x600                       | OCEANIA308G | OCEANIA308M | OCEANIA308A |
| 1000x550                       | OCEANIA309G | OCEANIA309M | OCEANIA309A |
| 900x840                        | OCEANIA323G | OCEANIA323M | OCEANIA323A |
| 900x550                        | OCEANIA310G | OCEANIA310M | OCEANIA310A |
| 900x500                        | OCEANIA311G | OCEANIA311M | OCEANIA311A |
| 900x450                        | OCEANIA312G | OCEANIA312M | OCEANIA312A |
| 900x350                        | OCEANIA313G | OCEANIA313M | OCEANIA313A |
| 800x550                        | OCEANIA314G | OCEANIA314M | OCEANIA314A |
| 800x400                        | OCEANIA315G | OCEANIA315M | OCEANIA315A |
| 700x500                        | OCEANIA316G | OCEANIA316M | OCEANIA316A |
| 700x350                        | OCEANIA317G | OCEANIA317M | OCEANIA317A |
| 700x300                        | OCEANIA318G | OCEANIA318M | OCEANIA318A |
| 600x550                        | OCEANIA319G | OCEANIA319M | OCEANIA319A |
| 550x550                        | OCEANIA320G | OCEANIA320M | OCEANIA320A |
| 500x500                        | OCEANIA321G | OCEANIA321M | OCEANIA321A |
| 350x550                        | OCEANIA322G | OCEANIA322M | OCEANIA322A |

# FRANCIA MODEL

Panel compatible with Parapress® & Polyplastic® up to year 2000



**PMMA panel**

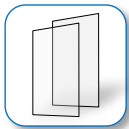

**Double glass**



**Hinge included**



**Certified window**



| Cutout Dimension W x H (mm) | Grey    | Bronze  |
|-----------------------------|---------|---------|
|                             | Art. No | Art. No |
| 1600x720                    | 1041AG  | 1041AB  |
| 1550x730                    | 1047AG  | 1047AB  |
| 1400x720                    | 1040AG  | ---     |
| 1350x780                    | 1046AG  | 1046AB  |
| 1350x730                    | 1045AG  | 1045AB  |

# ARCA MODEL



**PMMA panel**

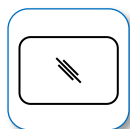

**Sheet panel without frame**



**Accessories not included**

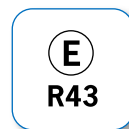

**Certified window**



| Sheet Dimension W x H (mm) | Bronze   |
|----------------------------|----------|
|                            | Art. No  |
| 1655x595                   | 1655x595 |
| 1405x505                   | 1405x505 |
| 1395x505                   | 1395x505 |
| 1255x495                   | 1255x495 |
| 1255x245                   | 1255x245 |
| 855x505                    | 855x505  |
| 855x495                    | 855x495  |
| 655x245                    | 655x245  |

# MODEL 2

Mosquito-net blinds suitable for various camper van windows



**Simple assembly**



**Almost complete blackout**



**Effective insect protection**



**Color of the mosquito-net: grey**



**Frame material: plastic**



Manual adjustment mechanism



useful information



| Cutout Dimension<br>W x H (mm) | Grey    | Ivory   |
|--------------------------------|---------|---------|
|                                | Art. No | Art. No |
| 1800x650                       | 6018OZG | 6018OZA |
| 1700x650                       | 6017OZG | 6017OZA |
| 1600x650                       | 6016OZG | 6016OZA |
| 1500x650                       | 6015OZG | 6015OZA |
| 1450x650                       | 6014OZG | 6014OZA |
| 1400x650                       | 6013OZG | 6013OZA |
| 1300x650                       | 6012OZG | 6012OZA |
| 1250x650                       | 6011OZG | 6011OZA |
| 1200x650                       | 6010OZG | 6010OZA |
| 1100x650                       | 6009OZG | 6009OZA |
| 1000x650                       | 6008OZG | 6008OZA |
| 900x650                        | 6007OZG | 6007OZA |
| 800x650                        | 6006OZG | 6006OZA |
| 700x650                        | 6005OZG | 6005OZA |
| 600x650                        | 6004OZG | 6004OZA |
| 500x650                        | 6003OZG | 6003OZA |
| 450x650                        | 6002OZG | 6002OZA |
| 350x650                        | 6001OZG | 6001OZA |

# MODEL 3 014

Mosquito-net blinds suitable for various camper van windows



**Simple assembly**



**Almost complete blackout**



**Effective insect protection**



**Color of the mosquito-net: grey**



**Frame material: plastic**



Single packaging box

useful information



| Cutout Dimension<br>W x H (mm) | Grey     | Ivory    |
|--------------------------------|----------|----------|
|                                | Art. No  | Art. No  |
| 1800x650                       | MOD3101G | MOD3101A |
| 1700x650                       | MOD3102G | MOD3102A |
| 1600x650                       | MOD3103G | MOD3103A |
| 1500x650                       | MOD3104G | MOD3104A |
| 1450x650                       | MOD3105G | MOD3105A |
| 1400x650                       | MOD3106G | MOD3106A |
| 1300x650                       | MOD3107G | MOD3107A |
| 1200x650                       | MOD3108G | MOD3108A |
| 1100x650                       | MOD3109G | MOD3109A |
| 1000x650                       | MOD3110G | MOD3110A |
| 900x650                        | MOD3111G | MOD3111A |
| 800x650                        | MOD3112G | MOD3112A |
| 700x650                        | MOD3113G | MOD3113A |
| 600x650                        | MOD3114G | MOD3114A |
| 500x650                        | MOD3115G | MOD3115A |
| 450x650                        | MOD3116G | MOD3116A |
| 350x650                        | MOD3117G | MOD3117A |

# MODEL EVO

Mosquito-net blinds suitable for various camper van windows



**Simple assembly**



**Almost complete blackout**



**Effective insect protection**



**Color of the mosquito-net: grey**



**Frame material: plastic**

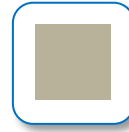

**Frame color: ivory**

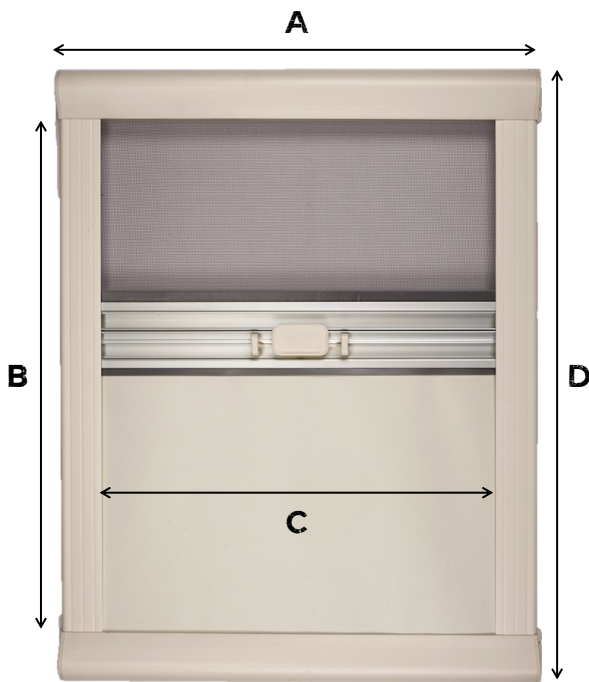

| Cutout Dimension W x H (mm) | A (mm) | B (mm) | C (mm) | D (mm) | Art. No  |
|-----------------------------|--------|--------|--------|--------|----------|
| 1800x650                    | 1894   | 650    | 1800   | 750    | 60018EVO |
| 1700x650                    | 1794   | 650    | 1700   | 750    | 60017EVO |
| 1600x650                    | 1694   | 650    | 1600   | 750    | 60016EVO |
| 1500x650                    | 1594   | 650    | 1500   | 750    | 60015EVO |
| 1450x650                    | 1544   | 650    | 1450   | 750    | 60014EVO |
| 1400x650                    | 1494   | 650    | 1400   | 750    | 60013EVO |
| 1300x650                    | 1394   | 650    | 1300   | 750    | 60012EVO |
| 1250x650                    | 1344   | 650    | 1250   | 750    | 60011EVO |
| 1200x650                    | 1294   | 650    | 1200   | 750    | 60010EVO |
| 1100x650                    | 1194   | 650    | 1100   | 750    | 6009EVO  |
| 1000x650                    | 1094   | 650    | 1000   | 750    | 6008EVO  |
| 900x650                     | 994    | 650    | 900    | 750    | 6007EVO  |
| 800x650                     | 894    | 650    | 800    | 750    | 6006EVO  |
| 700x650                     | 794    | 650    | 700    | 750    | 6005EVO  |
| 600x650                     | 694    | 650    | 600    | 750    | 6004EVO  |
| 500x650                     | 594    | 650    | 500    | 750    | 6003EVO  |
| 450x650                     | 544    | 650    | 450    | 750    | 6002EVO  |
| 350x650                     | 444    | 650    | 350    | 750    | 6001EVO  |

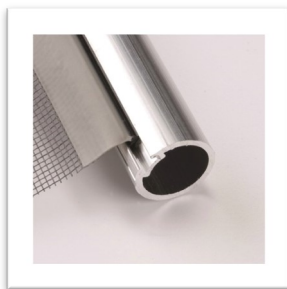

TOP PART: mosquito net electro-welded with coextruded trim

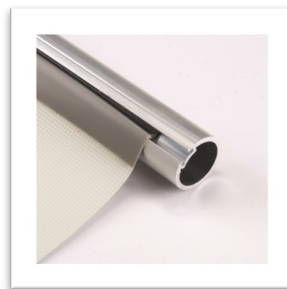

TOP PART: blind electro-welded with coextruded trim

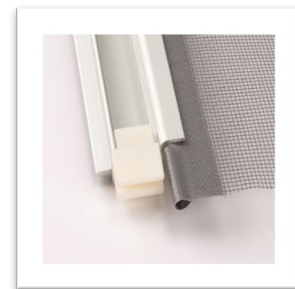

BOTTOM PART: mosquito-net electro-welded with fiberglass tape

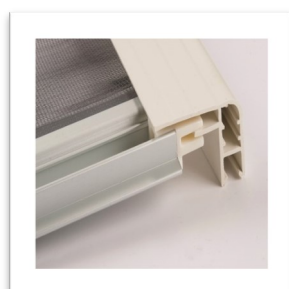

Side sliding track

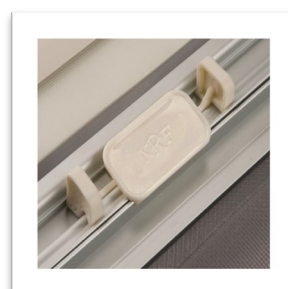

Handle with retractable underwire

useful information



# MODEL FS

Mosquito-net and blinds suitable for various camper van windows



Simple assembly



Almost complete blackout



Effective insect protection



Color of the mosquito-net: grey



Color of the blind: grey

MOSQUITO-NET



BLIND



| Cutout Dimension W x H (mm) | Art. No |
|-----------------------------|---------|
| 1900x800                    | 7015FSZ |
| 1800x800                    | 7014FSZ |
| 1700x800                    | 7013FSZ |
| 1600x800                    | 7012FSZ |
| 1500x800                    | 7011FSZ |
| 1400x800                    | 7010FSZ |
| 1300x800                    | 7009FSZ |
| 1200x800                    | 7008FSZ |
| 1100x800                    | 7007FSZ |
| 1000x800                    | 7006FSZ |
| 900x800                     | 7005FSZ |
| 800x800                     | 7004FSZ |
| 700x800                     | 7003FSZ |
| 600x800                     | 7002FSZ |
| 500x800                     | 7001FSZ |

| Cutout Dimension W x H (mm) | Art. No |
|-----------------------------|---------|
| 1900x800                    | 7015FSO |
| 1800x800                    | 7014FSO |
| 1700x800                    | 7013FSO |
| 1600x800                    | 7012FSO |
| 1500x800                    | 7011FSO |
| 1400x800                    | 7010FSO |
| 1300x800                    | 7009FSO |
| 1200x800                    | 7008FSO |
| 1100x800                    | 7007FSO |
| 1000x800                    | 7006FSO |
| 900x800                     | 7005FSO |
| 800x800                     | 7004FSO |
| 700x800                     | 7003FSO |
| 600x800                     | 7002FSO |
| 500x800                     | 7001FSO |

useful information



## ACCESSORIES & SPARE PARTS

Internal & External Blinds

# ACCESSORIES & SPARE PARTS

for NRF internal blinds

### SUCTION CUPS



| Description                          | Art. No |
|--------------------------------------|---------|
| Standard plastic grey color          | 970VL   |
| Standard plastic black color         | 974VL   |
| Plastic grey color with screw & nut  | 972VL   |
| Plastic transparent with screw & nut | 973VL   |

### EYELETS

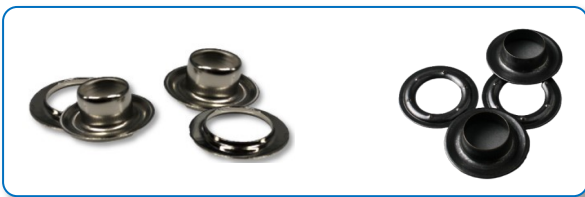

| Description                        | Art. No |
|------------------------------------|---------|
| Metallic eyelets sold in pair      | 971OC   |
| Black plastic eyelets sold in pair | 972OC   |

### ROLLS 100 mt OF HEMMING MATERIAL



| Description                  | Art. No |
|------------------------------|---------|
| White & grey spike base      | 881B    |
| Light & dark grey spike base | 882B    |
| Dark grey & black spike base | 883B    |
| Total black base             | 884B    |

# ACCESSORIES & SPARE PARTS

for NRF external blinds



| Description   | Art. No |
|---|---------|
| Total grey base   | 880B    |
| Total black base  | 885B    |
| Luxury suction cup for Covertech Evolution (motorhomes) | 880V    |

# ACCESSORIES & SPARE PARTS

for NRF mosquito-net blinds

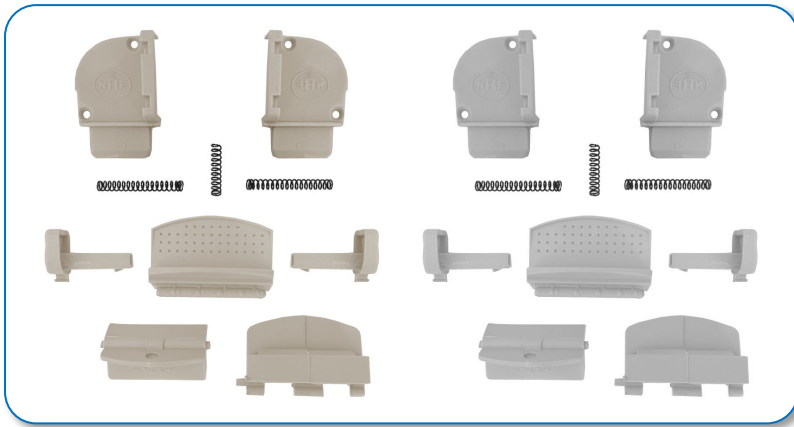

| Description               | Art. No |
|---------------------------|---------|
| MOD. 2 ivory complete kit | 6050RA  |
| MOD. 2 grey complete kit  | 6050RG  |

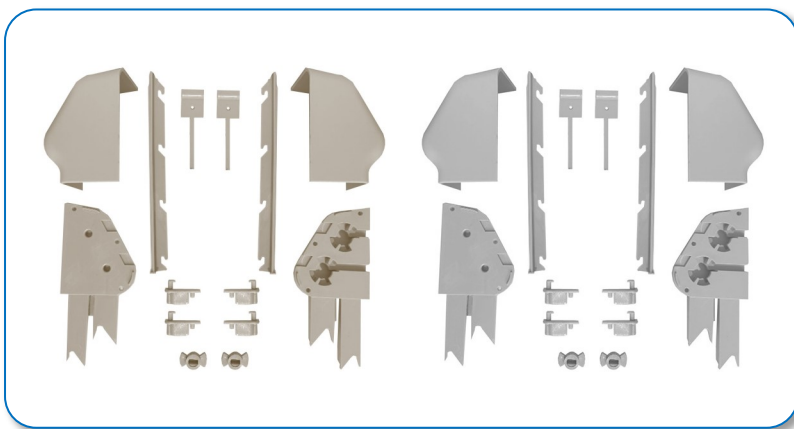

| Description                   | Art. No   |
|-------------------------------|-----------|
| MOD. 3 014 ivory complete kit | MOD3RICAV |
| MOD. 3 014 grey complete kit  | MOD3RICGR |

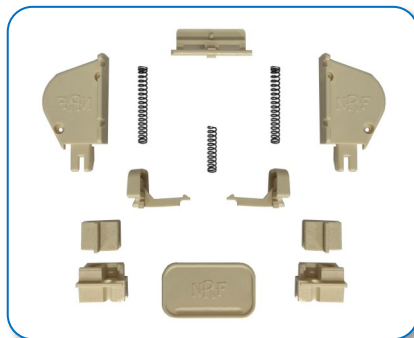

| Description                 | Art. No  |
|-----------------------------|----------|
| MOD. EVO ivory complete kit | 6030EVOR |

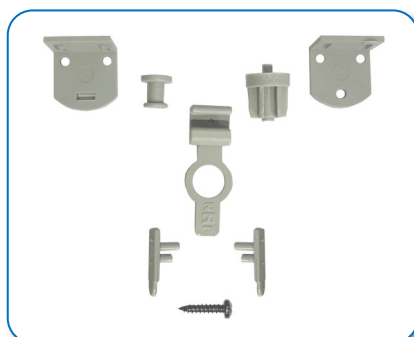

| Description               | Art. No |
|---------------------------|---------|
| MOD. FS grey complete kit | 7050FSR |

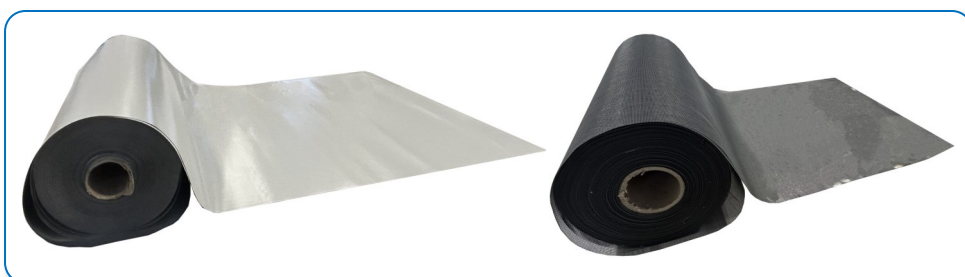

| Description                                  | Art. No |
|--|---------|
| Blind roll h 70 cm<br>(roll is 100 mt)       | 89407   |
| Mosquito-net roll h 80 cm<br>(roll is 90 mt) | 895Z8   |

# ACCESSORIES & SPARE PARTS

for NRF window panels

EUROPA & FRANCIA MODELS

## ASSEMBLY ACCESSORIES COMPLETE KIT

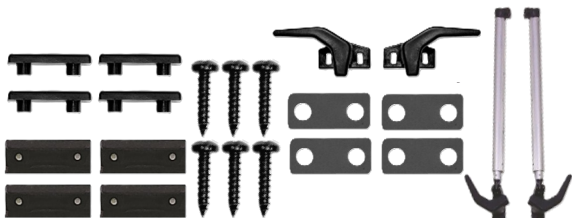

| Description                          | Art. No  |
|--------------------------------------|----------|
| 6 holes click-clack arm complete kit | KIT5005R |
| 5 holes click-clack arm complete kit | KIT5006R |
| 4 holes click-clack arm complete kit | KIT5007R |
| 3 holes click-clack arm complete kit | KIT5008R |
| 2 holes click-clack arm complete kit | KIT5009R |
| 1 hole click-clack arm complete kit  | KIT5010R |

## INDIVIDUAL ASSEMBLY ACCESSORIES

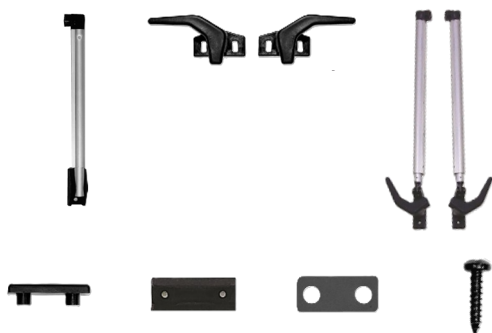

| Description   | Art. No     |
|---|-------------|
| 6 holes click-clack plain single arm                    | 5005R       |
| 5 holes click-clack plain single arm                    | 5006R       |
| 4 holes click-clack plain single arm                    | 5007R       |
| 3 holes click-clack plain single arm                    | 5008R       |
| 2 holes click-clack plain single arm                    | 5009R       |
| 1 hole click-clack plain single arm                     | 5010R       |
| Right or left plain handle                              | 5018RDX-RSX |
| 6 holes click-clack arm with right & left handle (pair) | 5001RDX-RSX |
| 5 holes click-clack arm with right & left handle (pair) | 5002RDX-RSX |
| 4 holes click-clack arm with right & left handle (pair) | 5003RDX-RSX |
| 3 holes click-clack arm with right & left handle (pair) | 5004RDX-RSX |
| External plastic plate mm 0,7                           | 5021R       |
| Plastic lock  | 5022R       |
| Sticky rubber seal                                      | 5023R       |
| Threaded screw 3,9x13                                   | 5024R       |

## HINGES

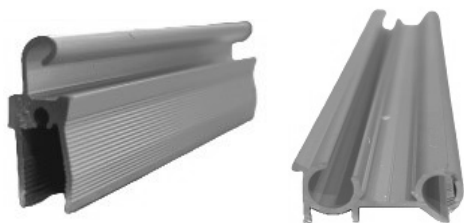

| Description                             | Art. No |
|---|---------|
| Hinge (to mount on the window panel)    | 5030R   |
| Counter hinge (to mount on the vehicle) | 5032R   |

## UNIVERSAL RUBBERS (for all NRF panel models)



| Description   | Art. No |
|---|---------|
| Rubber mm 28-30 (to use on the vehicle)               | 5027R   |
| Rubber (to use inside the aluminium bar of the panel) | 5029R   |

## DOUBLE GLAZED MODEL

### ASSEMBLY ACCESSORIES COMPLETE KIT



### INDIVIDUAL ASSEMBLY ACCESSORIES



### HINGE

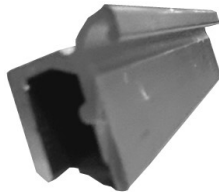

| Description                         | Art. No  |
|-------------------------------------|----------|
| 600 mm click-clack arm complete kit | KIT5011R |
| 550 mm click-clack arm complete kit | KIT5012R |
| 500 mm click-clack arm complete kit | KIT5013R |
| 450 mm click-clack arm complete kit | KIT5014R |
| 400 mm click-clack arm complete kit | KIT5015R |
| 350 mm click-clack arm complete kit | KIT5016R |
| 300 mm click-clack arm complete kit | KIT5017R |

| Description  | Art. No     |
|--|-------------|
| 600 mm click-clack arm with right & left handle (pair) | 5011R       |
| 550 mm click-clack arm with right & left handle (pair) | 5012R       |
| 500 mm click-clack arm with right & left handle (pair) | 5013R       |
| 450 mm click-clack arm with right & left handle (pair) | 5014R       |
| 400 mm click-clack arm with right & left handle (pair) | 5015R       |
| 350 mm click-clack arm with right & left handle (pair) | 5016R       |
| 300 mm click-clack arm with right & left handle (pair) | 5017R       |
| Right or left plain handle                             | 5019RDX-RSX |
| Sticky rubber seal                                     | 5025R       |
| Zinc-plated screw 5x16                                 | 5026R       |

| Description                          | Art. No |
|--------------------------------------|---------|
| Hinge (to mount on the window panel) | 5034R   |

## AFRICA, ASIA & OCEANIA MODELS

### ASSEMBLY ACCESSORIES COMPLETE KIT



### INDIVIDUAL ASSEMBLY ACCESSORIES



### HINGES

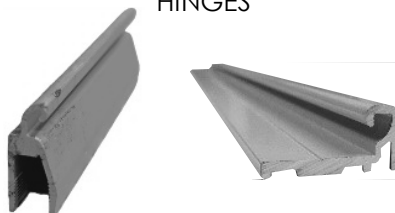

| Description                         | Art. No  |
|-------------------------------------|----------|
| 600 mm click-clack arm complete kit | KIT5036R |
| 550 mm click-clack arm complete kit | KIT5037R |
| 500 mm click-clack arm complete kit | KIT5038R |
| 450 mm click-clack arm complete kit | KIT5039R |
| 400 mm click-clack arm complete kit | KIT5040R |
| 350 mm click-clack arm complete kit | KIT5041R |
| 300 mm click-clack arm complete kit | KIT5042R |

| Description  | Art. No     |
|--|-------------|
| 600 mm click-clack arm with right & left handle (pair) | 5011R       |
| 550 mm click-clack arm with right & left handle (pair) | 5012R       |
| 500 mm click-clack arm with right & left handle (pair) | 5013R       |
| 450 mm click-clack arm with right & left handle (pair) | 5014R       |
| 400 mm click-clack arm with right & left handle (pair) | 5015R       |
| 350 mm click-clack arm with right & left handle (pair) | 5016R       |
| 300 mm click-clack arm with right & left handle (pair) | 5017R       |
| Right or left plain handle                             | 5019RDX-RSX |
| External plastic plate                                 | 5043R       |
| Plastic lock   | 5044R       |
| Sticky rubber seal                                     | 5025R       |
| Zinc-plated screw 5x16                                 | 5026R       |

| Description                             | Art. No |
|---|---------|
| Hinge (to mount on the window panel)    | 5032R   |
| Counter hinge (to mount on the vehicle) | 5028R   |



Registered Office: Via Vespucci nr. 32 - 24050 Grassobbio (BG) ITALY

Operational Headquarter: Via Ca' de Testi nr. 32 - 40037 Sasso Marconi (BO) ITALY

0039 051-917802 info@nrfcamper.it www.nrfcamper.it